

Loadable up to 3000 kg!

Individual parking spaces can even be loaded retrospectively!

Dimensions

All space requirements are minimum finished dimensions.
Tolerances for space requirements ⁺³₀ dimensions in cm.

Suitable for

Standard passenger vehicle:
Limousine, Station Sagon, SUV, Van according to clearance and maximum surface load.

Width	190 cm	190 cm	190 cm
Weight	max. 2000 kg	max. 2600 kg	max. 3000 kg
Wheel load	max. 500 kg	max. 650 kg	max. 750 kg

Clearance profile

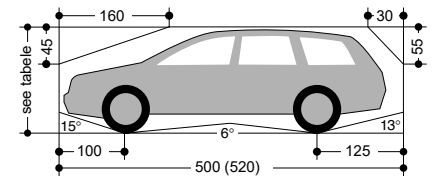

Building version with vertical gate

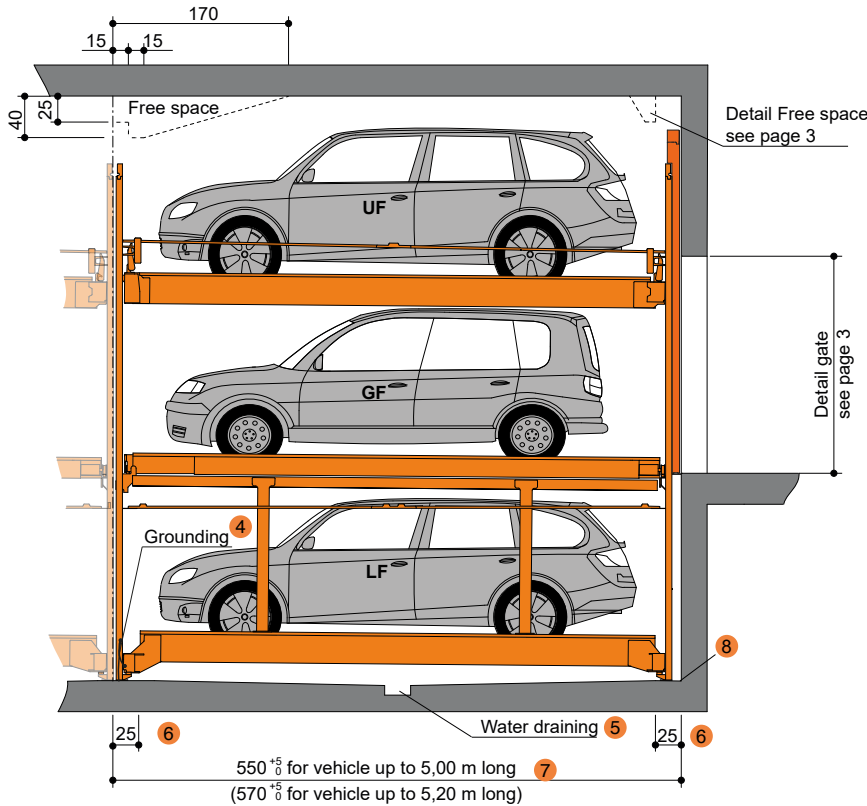

Gate variants see pages 3 to 6

Examples KombiSystem

Combination 6300 with 6300+

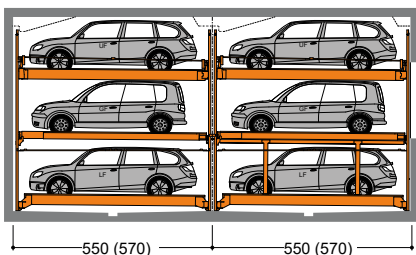

Combination 6100 with 6300+

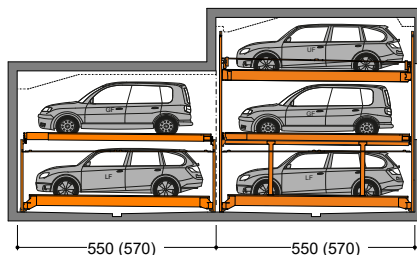

Combination 6200+ with 6300+

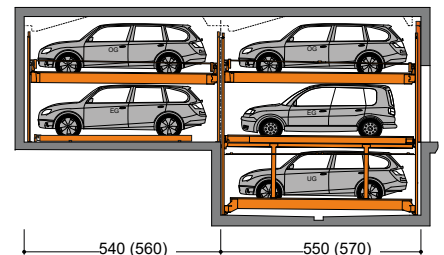

- Maximum load possible at additional cost.
- To follow the minimum finished dimensions, make sure to consider the tolerances according to VOB, part C (DIN 18330 and 18331) and the DIN 18202
- Vehicle width for platform width 230 cm. If wider platforms are used it is also possible to park wider vehicle.
- Potential equalization from foundation grounding connection to system (provided by the customer).
- Slope with drainage channel and sump.
- Tolerances for the evenness of the carriageway (floor) must be strictly complied with in accordance with DIN 18202, chart 3, line 3..
- For convenient use of your parking space and due to the fact that the cars keep becoming longer we recommend a pit length of 570 cm .
- At the transition section between pit floor and walls no hollow mouldings/coves are possible. If hollow mouldings/coves are required, the systems must be designed smaller or the pits accordingly wider.



If sprinklers are required make sure to provide the necessary free spaces during the planning stage.

Page 1
Section
Vehicle data

Page 2
Height
dimensions

Page 3
Vertical gate
width
dimensions

Page 4
Sliding gate
width
dimensions

Page 5
Sliding gate
width
dimensions

Page 6
Sliding gate
width
dimensions

Page 7
Arrangement of
the grid
Approach
Free spaces
Function

Page 8
Load plan

Page 9
Technical
data

Page 10
Electrical
To be performed by the customer

Page 11
Description

Page 12
Description

Page 1
Section
Vehicle data

Page 2
Height
dimensions

Page 3
Vertical gate
width
dimensions

Page 4
Sliding gate
width
dimensions

Page 5
Sliding gate
width
dimensions

Page 6
Sliding gate
width
dimensions

Page 7
Arrangement of
the grid
Approach
Free spaces
Function

Page 8
Load plan

Page 9
Technical
data

Page 10
Electrical
To be performed by the
customer

Page 11
Description

Page 12
Description

Height dimensions



The permissible vehicle height GF must be 10cm larger than vehicle height LF.

Type	GT	Vehicle height LF
6300+ / 200	200	150
6300+ / 205	205	155
6300+ / 210	210	160
6300+ / 215	215	165
6300+ / 220	220	170
6300+ / 225	225	175
6300+ / 230	230	180
6300+ / 235	235	185
6300+ / 240	240	190
6300+ / 245	245	195
6300+ / 250	250	200

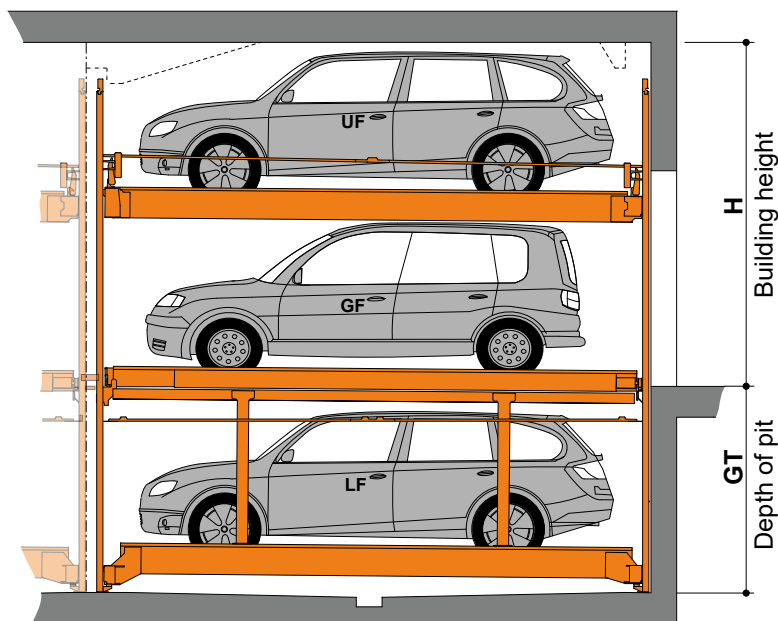

Vehicle height GF	Vehicle height UF															H - Building height
	150	155	160	165	170	175	180	185	190	195	200	205	210	215	220	
160	335	340	345	350	355	360	365	370	375	380	385	390	395	400	405	
165	340	345	350	355	360	365	370	375	380	385	390	395	400	405	410	
170	345	350	355	360	365	370	375	380	385	390	395	400	405	410	415	
175	350	355	360	365	370	375	380	385	390	395	400	405	410	415	420	
180	355	360	365	370	375	380	385	390	395	400	405	410	415	420	425	
185	360	365	370	375	380	385	390	395	400	405	410	415	420	425	430	
190	365	370	375	380	385	390	395	400	405	410	415	420	425	430	435	
195	370	375	380	385	390	395	400	405	410	415	420	425	430	435	440	
200	375	380	385	390	395	400	405	410	415	420	425	430	435	440	445	
205	380	385	390	395	400	405	410	415	420	425	430	435	440	445	450	
210	385	390	395	400	405	410	415	420	425	430	435	440	445	450	455	
215	390	395	400	405	410	415	420	425	430	435	440	445	450	455	460	

Example of configuration

Example of configuration 1:

Vehicle UF: 150 Type: **6300+ / 225**

Vehicle GF: 190

Vehicle LF: 175 Height: **365**

Example of configuration 2:

Vehicle UF: 160 Type: **6300+ / 230**

Vehicle GF: 160

Vehicle LF: 180 Height: **Selection not possible!!!**



Configuration 2 is not possible because the maximum permissible vehicle GF is smaller than the vehicle LF. The larger vehicle LF cannot retract.

Page 1
Section
Vehicle data

Page 2
Height
dimensions

Page 3
Vertical gate
width
dimensions

Page 4
Sliding gate
width
dimensions

Page 5
Sliding gate
width
dimensions

Page 6
Sliding gate
width
dimensions

Page 7
Arrangement of
the grid
Approach
Free spaces
Function

Page 8
Load plan

Page 9
Technical
data

Page 10
Electrical
To be perfor-
med by the
customer

Page 11
Description

Page 12
Description

Garages with vertical gates | Width dimensions

Gate behind columns

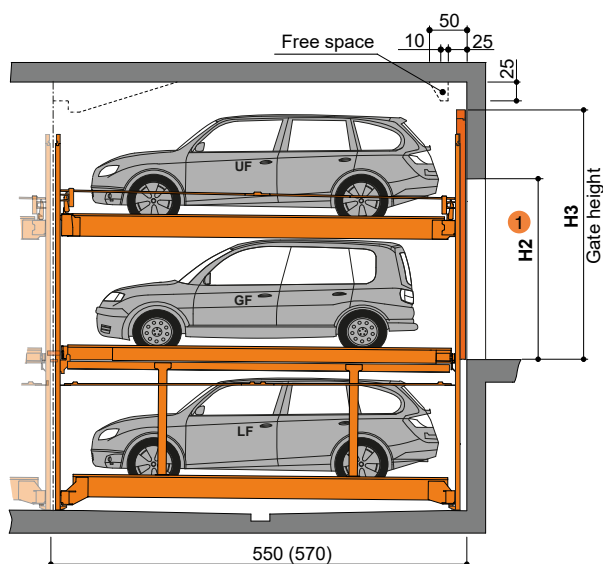

max. Vehicle height UF / GF	H2	H3
160	210	325
165	210	325
170	210	335
175	210	335
180	210	335
185	210	360
190	210	360
195	210	360
200	210	360
205	215	360
210	220	385
215	225	385
220	230	385

Columns per each grid unit

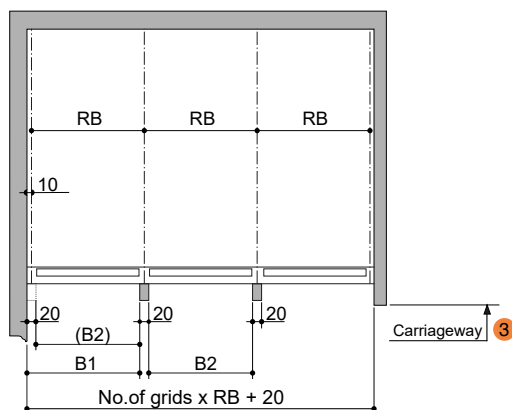

Usable platform width	RB	B1	B2
230	250	250	230
240	260	260	240
250	270	270	250
260	280	280	260
270	290	290	270

Columns every second grid unit

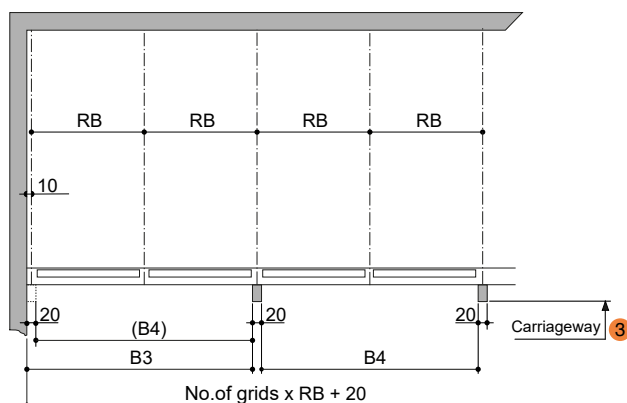

Usable platform width	RB	B3	B4
230	250	500	480
240	260	520	500
250	270	540	250
260	280	560	540
270	290	580	560



In accordance with ASR A1.7, an inspection book is required for a gate with electric drive that is intended for commercial use. Prior to commissioning and annually thereafter, the gate must be inspected by a qualified expert and the findings recorded in the inspection book. The inspection must be performed independently of any maintenance work.

We generally recommend our maximum platform width of 270 cm for corner boxes and boxes with dividing walls. The adjoining grid must be taken into account during planning. Narrower platform widths can cause problems during operation (depending on the vehicle type, access situation and individual driving behaviour).

For large limousines and SUVs, the access lanes may need to be widened (especially in the case of corner boxes with an insufficient manoeuvring radius)

- 1 Minimum clear height H2 to local regulations.
- 2 RB = Grid unit width **must** strictly conform to dimensions quotes!
- 3 Observe minimum carriageway width according to local regulations.

Page 1
Section
Vehicle data

Page 2
Height
dimensions

Page 3
Vertical gate
width
dimensions

Page 4
Sliding gate
width
dimensions

Page 5
Sliding gate
width
dimensions

Page 6
Sliding gate
width
dimensions

Page 7
Arrangement of
the grid
Approach
Free spaces
Function

Page 8
Load plan

Page 9
Technical
data

Page 10
Electrical
To be performed by
the customer

Page 11
Description

Page 12
Description

Garages with sliding gates | Widths dimensions

Sliding gate behind columns

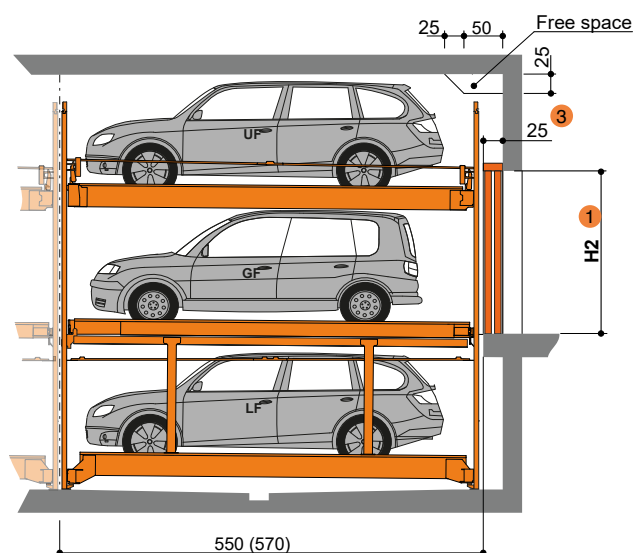

max. Vehicle height UF / GF	H2
160	210
165	210
170	210
175	210
180	210
185	210
190	210
195	210
200	210
205	215
210	220
215	225
220	230

Columns per each grid unit

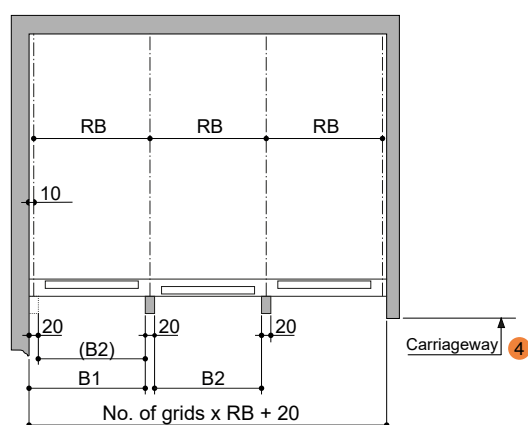

Usable platform width	RB	B1	B2
230	250	250	230
240	260	260	240
250	270	270	250
260	280	280	260
270	290	290	270

Columns every second grid unit

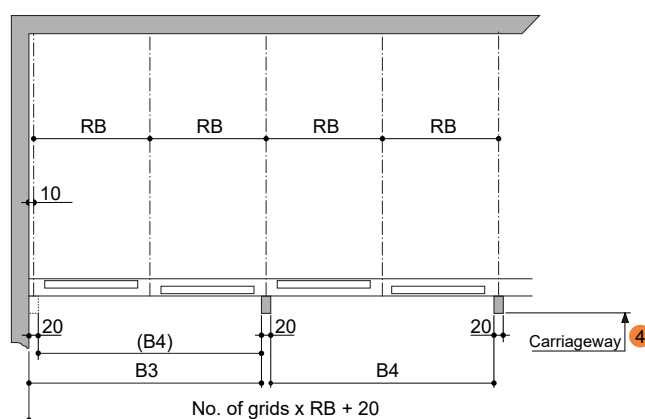

Usable platform width	RB	B3	B4
230	250	500	480
240	260	520	500
250	270	540	250
260	280	560	540
270	290	580	560



In accordance with ASR A1.7, an inspection book is required for a gate with electric drive that is intended for commercial use. Prior to commissioning and annually thereafter, the gate must be inspected by a qualified expert and the findings recorded in the inspection book. The inspection must be performed independently of any maintenance work.

We generally recommend our maximum platform width of 270 cm for corner boxes and boxes with dividing walls. The adjoining grid must be taken into account during planning. Narrower platform widths can cause problems during operation (depending on the vehicle type, access situation and individual driving behaviour).

For large limousines and SUVs, the access lanes may need to be widened (especially in the case of corner boxes with an insufficient manoeuvring radius)

- 1 Minimum clear height H2 to local regulations.
- 2 RB = Grid unit width **must** strictly conform to dimensions quotes!
- 3 Only applies to manually operated gates. The electrically driven gates must have 35 cm.
- 4 Observe minimum carriageway width according to local regulations.

Garages with sliding gates | Widths dimensions

Sliding gate in front of columns

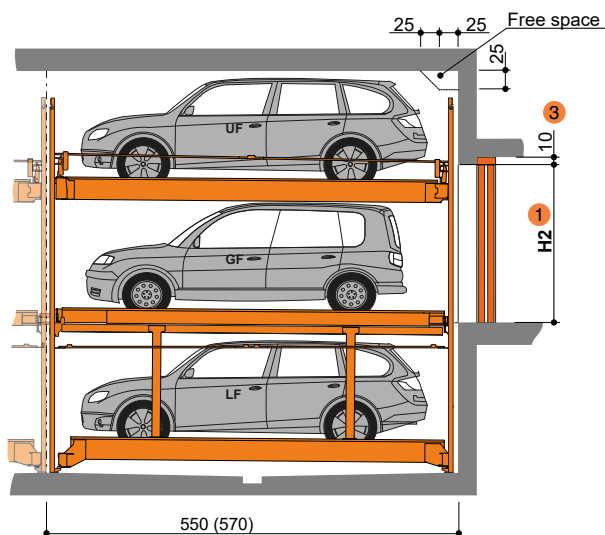

max. Vehicle height UF / GF	H2
160	210
165	210
170	210
175	210
180	210
185	210
190	210
195	215
200	215
205	220
210	225
215	230
220	235

Columns per each grid unit

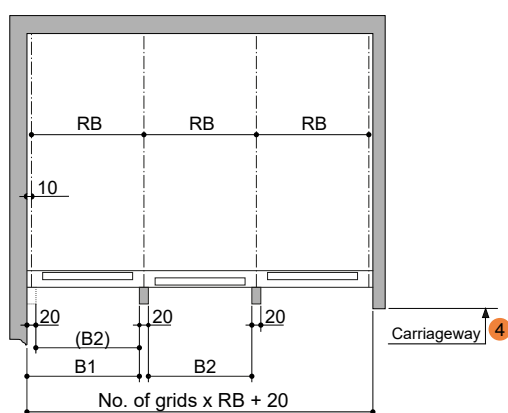

Usable platform width	RB	B1	B2
230	250	250	230
240	260	260	240
250	270	270	250
260	280	280	260
270	290	290	270

Columns every second grid unit

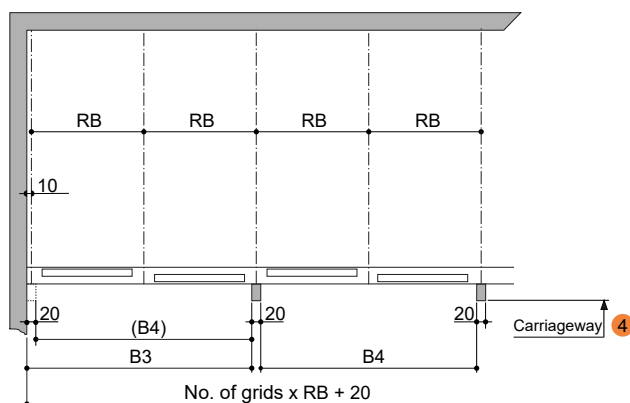

Usable platform width	RB	B3	B4
230	250	500	480
240	260	520	500
250	270	540	250
260	280	560	540
270	290	580	560



In accordance with ASR A1.7, an inspection book is required for a gate with electric drive that is intended for commercial use. Prior to commissioning and annually thereafter, the gate must be inspected by a qualified expert and the findings recorded in the inspection book. The inspection must be performed independently of any maintenance work.

We generally recommend our maximum platform width of 270 cm for corner boxes and boxes with dividing walls. The adjoining grid must be taken into account during planning. Narrower platform widths can cause problems during operation (depending on the vehicle type, access situation and individual driving behaviour).

For large limousines and SUVs, the access lanes may need to be widened (especially in the case of corner boxes with an insufficient manoeuvring radius)

- 1 Minimum clear height H2 to local regulations.
- 2 RB = Grid unit width **must** strictly conform to dimensions quotes!
- 3 Only applies to manually operated gates. The electrically driven gates must have 35 cm.
- 4 Observe minimum carriageway width according to local regulations.

Page 1
Section
Vehicle data

Page 2
Height
dimensions

Page 3
Vertical gate
width
dimensions

Page 4
Sliding gate
width
dimensions

Page 5
Sliding gate
width
dimensions

Page 6
Sliding gate
width
dimensions

Page 7
Arrangement of
the grid
Approach
Free spaces
Function

Page 8
Load plan

Page 9
Technical
data

Page 10
Electrical
To be performed by
the customer

Page 11
Description

Page 12
Description

Arrangement of the grid combination system

For 2 rows max. 10 grids

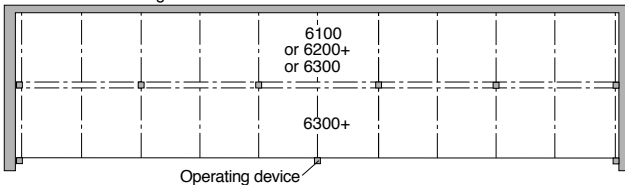

For 3 rows max. 6 grids

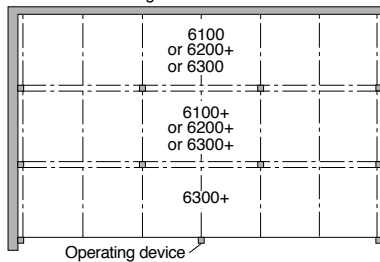

For 4 rows max. 4 grids

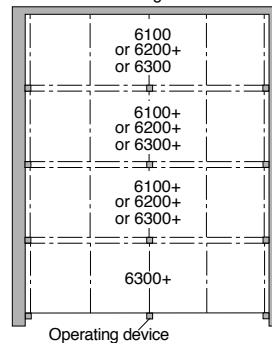

Approach

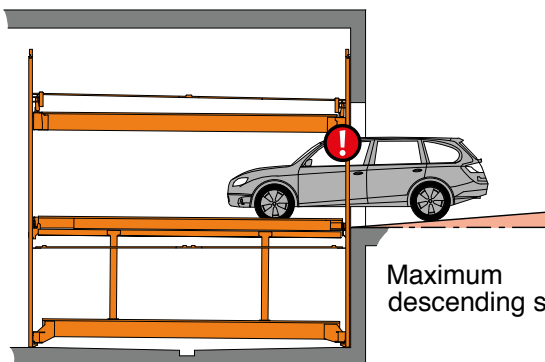

Maximum descending slope 3 %

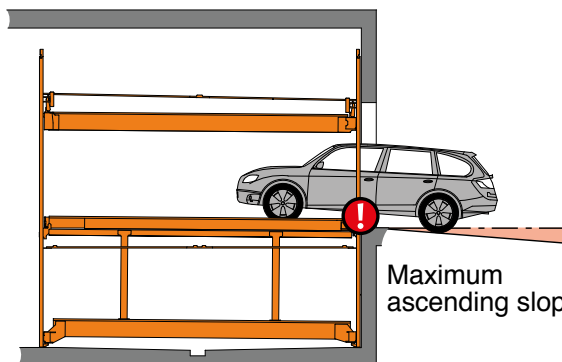

Maximum ascending slope 5 %



The illustrated maximum approach angle must not be exceeded. Incorrect approach angle will cause serious manoeuvring & positioning problems on the parking system for which the local agency of KLAUS Multiparking accepts no responsibility.

Longitudinal free space

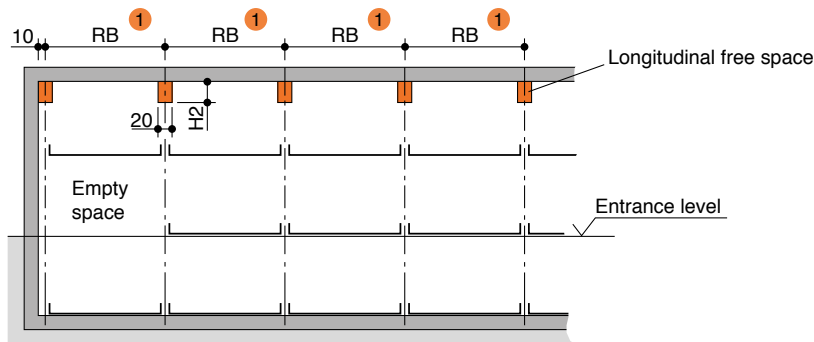

H2 ②	H2 max
Building height - 305	45

Function with standard numbering and identification of parking levels

e.g. for parking space No. 4: Check first that all doors are closed, then select No. 4 on operating panel.

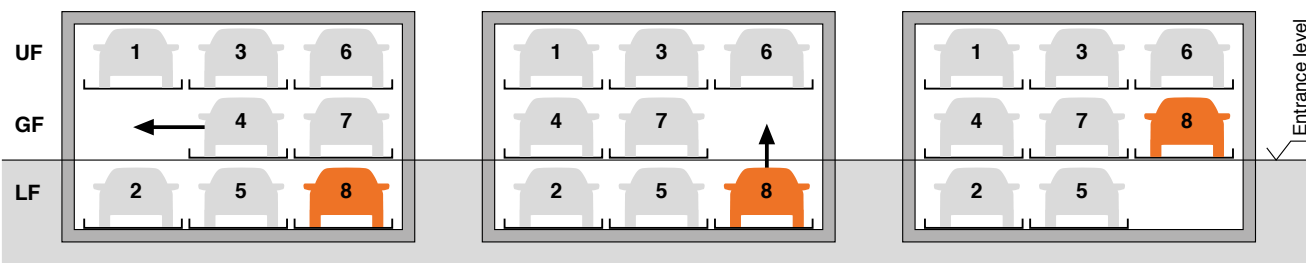

For driving the vehicle off platform No. 8 the ground floor parking platforms are shifted to the left

The empty space is now below the vehicle which shall be driven off the platform. The platform No. 8 will be lowered.

The vehicle on platform No. 8 can now be driven off the platform.

① RB = Grid unit width **must** strictly conform to dimensions quotes!

② Building height see page 2.

Page 1
Section
Vehicle data

Page 2
Height
dimensions

Page 3
Vertical gate
width
dimensions

Page 4
Sliding gate
width
dimensions

Page 5
Sliding gate
width
dimensions

Page 6
Sliding gate
width
dimensions

Page 7
Arrangement of
the grid
Approach
Free spaces
Function

Page 8
Load plan

Page 9
Technical
data

Page 10
Electrical
To be performed
by the customer

Page 11
Description

Page 12
Description

Load plan

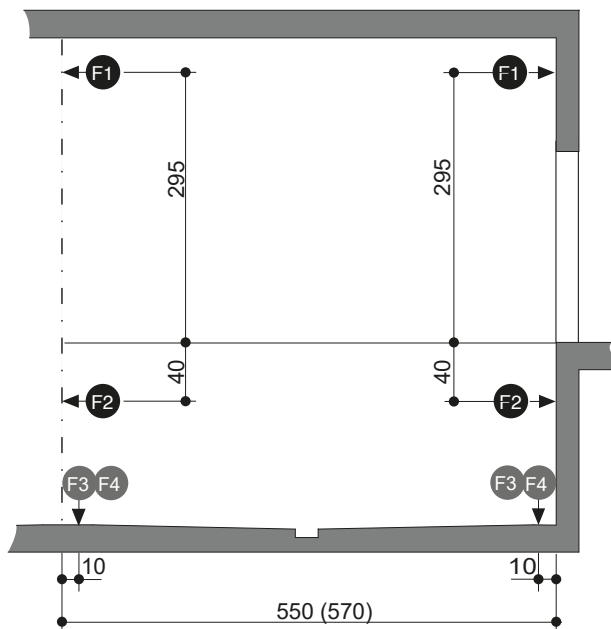

Load plan – top view

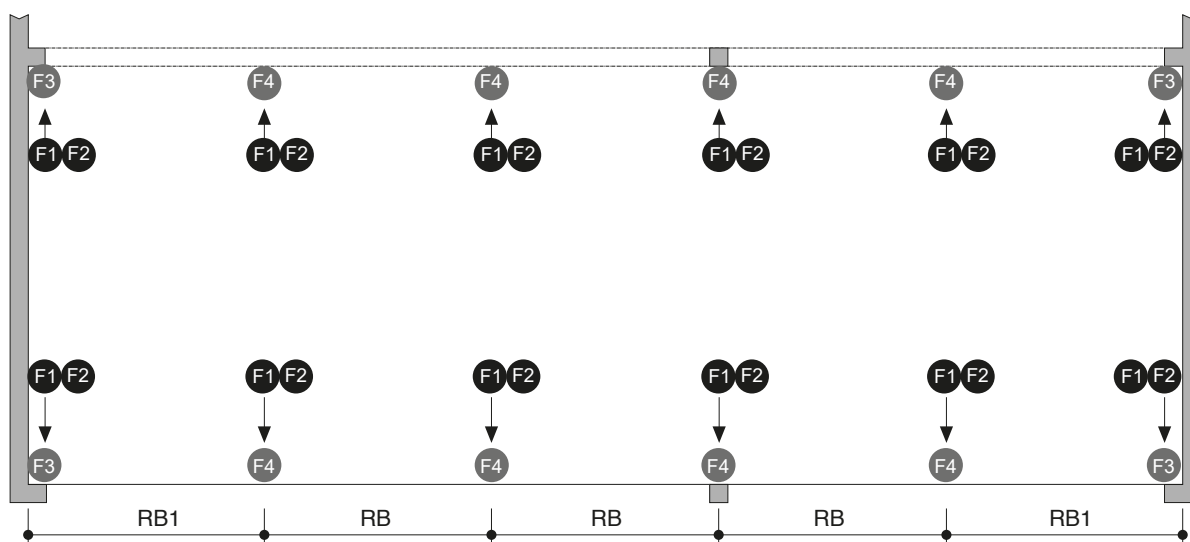

Usable platform width	1	
	RB	RB1
230	250	260
240	260	270
250	270	280
260	280	290
270	290	300

Platform load

Platform load	2			
	F1	F2	F3	F4
2000 kg	±0,5	±2,5	+30	+60
2600 kg	±0,8	±2,5	+39	+78
3000 kg	±1,0	±2,5	+42	+84



The system is dowelled to the floor and walls. The drilling depth in the base plate is approx. 15cm. The drilling depth in the walls is approx. 12cm.

The base plate and walls must be made of concrete (concrete quality min. C20/25)!

The dimensions of the support points are rounded. If the exact location is required, please contact KLAUS Multiparking.

1 RB = Grid unit width **must** strictly conform to dimensions quotes!

2 All forces in kN

Page 1
Section
Vehicle data

Page 2
Height
dimensions

Page 3
Vertical gate
width
dimensions

Page 4
Sliding gate
width
dimensions

Page 5
Sliding gate
width
dimensions

Page 6
Sliding gate
width
dimensions

Page 7
Arrangement of
the grid
Approach
Free spaces
Function

Page 8
Load plan

Page 9
Technical
data

Page 10
Electrical
To be performed by the customer

Page 11
Description

Page 12
Description

Technical data

Field of application

By default, the system are only for a fixed number of users. If different users use the system (e.g. short-time parkers in office buildings or hotels) the Multiparking system needs to be adjusted. If required, would you please contact us

Available documents

- wall recess plans
- maintenance offer/contract
- declaration of conformity
- test sheet on airborne and slide borne sound

Units

Low-noise power units mounted to rubber-bonded-to metal mountings are installed. Nevertheless we recommend that parking system's garage be built separately from the dwelling.

Numbering

Standard numbering of the parking spaces:

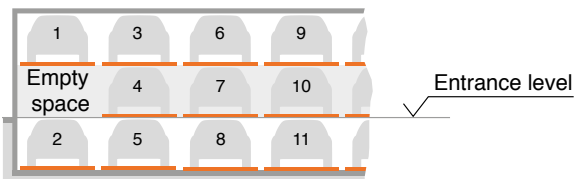

Different numbering is only possible at extra cost

Please take note of the following specifications:

- In general, the empty space must be arranged to the left.
- The numbers must be provided 8 – 10 weeks before the delivery date.

Environmental conditions

Environmental conditions for the area of multiparking systems:
Temperature range -10 to +40°C.
Relative humidity 50% at a maximum outside temperature of +40°C.

If lifting or lowering times are specified, they refer to an environmental temperature of +10°C and with the system set up directly next to the hydraulic unit. At lower temperatures or with longer hydraulic lines, these times increase.

Sound insulation

Normal sound insulation:

As per DIN 4109-1 sound insulation in building construction:
The Maximum sound level in living rooms and bedrooms must not exceed 30 dB (A).

User noises are not subject to the requirements (DIN 4109-1, section 9).

The following measures are required to comply with this value:

- Sound protection package according to offer/order (KLAUS Multiparking GmbH).
- Minimum sound insulation of the building of min. $R'w = 57$ dB (service/item to be provided by the customer)

Increased sound insulation (special agreement):

As per VDI 4100 sound insulation in building construction:
The Maximum sound level in living rooms and bedrooms must not exceed 25 dB (A).

User noises are not subject to the requirements (VDI 4100, paragraph 1).

The following measures are required to comply with this value:

- Sound protection package according to offer/order (KLAUS Multiparking GmbH).
- Minimum sound insulation of the building of min. $R'w = 62$ dB (service/item to be provided by the customer)

Note: User noises are basically noises that can be individually influenced by users of our multiparking systems. These include, for example, driving on the platform, slamming vehicle doors, engine and brake noises.

Electrically driven gates

In accordance with ASR A1.7 commercially used power-driven doors must be subjected to annual inspections. We urgently recommend concluding a maintenance agreement that includes this service for the entire system.

Building application documents

According to LBO and GaVo (garage regulations) the Multiparking systems are subject to approval. We will provide the required building application documents.

Care

To avoid damages resulting from corrosion, make sure to follow our cleaning and care instructions and to provide good ventilation of your garage.

Corrosion protection

See separate sheet regarding corrosion protection.

CE-Certification

The systems on offer comply with DIN EN 14010 and EC Machine Directive 2006/42/EC. Furthermore, this system underwent voluntary conformity testing by TÜV SÜD.

Page 1
Section
Vehicle data

Page 2
Height
dimensions

Page 3
Vertical gate
width
dimensions

Page 4
Sliding gate
width
dimensions

Page 5
Sliding gate
width
dimensions

Page 6
Sliding gate
width
dimensions

Page 7
Arrangement of
the grid
Approach
Free spaces
Function

Page 8
Load plan

Page 9
Technical
data

Page 10
Electrical
To be performed by the
customer

Page 11
Description

Page 12
Description

Electrical data

Control box

The control box must be accessible at all times from outside!
Dimensions approx. 40 x 60 x 30 cm.

Cutting through of wall from control box to parking system
(contact the local agency of KLAUS Multiparking for clarification).

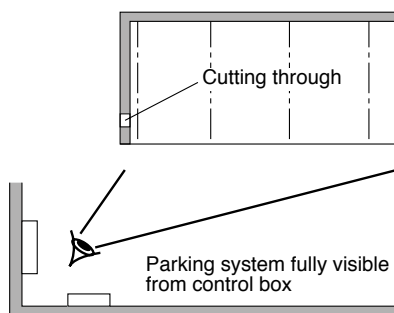

Electrical supply to the control box / Foundation earth connector

Suitable electrical supply min. 5 x 2,5 mm² (3 PH+N+PE) to control box with main fuse 3 x 16 A slow or over-current cut-out 3 x 16 A. Trigger characteristic K or C. DIN/VDE and local regulations must be taken into consideration.

Suitable electrical supply to the control box must be provided by the customer during installation. The functionality can be monitored on site by our fitters together with the electrician. If this cannot be done during installation for some reason for which the customer is responsible, the customer must commission an electrician at their own expense and risk.

In accordance with DIN EN 60204 (Safety of Machinery. Electrical Equipment), grounding of the steel structure is necessary, provided by the customer (distance between grounding max. 10 m)

Operating device

Easy-to-survey positioning (e.g. on column).

Protection against unauthorized use.

May also be recessed in wall if required.

To be performed by the customer

Safety fences

Any constraints that may be necessary according to DIN EN ISO13857 in order to provide protection, for pathways directly in front, next to or behind the unit. This is also valid during construction.

Numbering of parking spaces

Consecutive numbering of parking spaces.

Building services

Any required lighting, ventilation, fire extinguishing and fire alarm systems as well as clarification and compliance with the relevant regulatory requirements.

Drainage

For the middle area of the pit we recommend a drainage channel, which you connect to a floor drain system or sump (50 x 50 x 20 cm). The drainage channel may be inclined to the side, however not the pit floor itself (longitudinal incline is available). In the interests of environmental protection we recommend painting the pit floor. Oil and petrol separators must be provided according to the statutory provisions when connecting to the public sewage system!

Wall cuttings

Any necessary wall cuttings.

Electrical supply to the control box / Foundation earth connector

Suitable electrical supply to the control box must be provided by the customer during installation. The functionality can be monitored on site by our fitters together with the electrician. If this cannot be done during installation for some reason for which the customer is responsible, the customer must commission an electrician at their own expense and risk.

In accordance with DIN EN 60204 (Safety of Machinery. Electrical Equipment), grounding of the steel structure is necessary, provided by the customer (distance between grounding max. 10 m)

Strip footings

If due to structural conditions strip footings must be effected, the customer shall provide an accessible platform reaching to the top of the said strip footings to enable and facilitate themounting work.

Gate suspensions

The lintel height H2 (see page 3 to 5) is absolutely necessary. With different heights, additional fixings (gate suspensions) are required for extra charge.

Gate shields

Gate shields that may be necessary. If desired, they can be ordered from KLAUS Multiparking for an additional charge..

Page 1
Section
Vehicle data

Page 2
Height
dimensions

Page 3
Vertical gate
width
dimensions

Page 4
Sliding gate
width
dimensions

Page 5
Sliding gate
width
dimensions

Page 6
Sliding gate
width
dimensions

Page 7
Arrangement of
the grid
Approach
Free spaces
Function

Page 8
Load plan

Page 9
Technical
data

Page 10
Electrical
To be performed by the
customer

Page 11
Description

Page 12
Description

Description

General description

Multiparking system providing independent parking spaces for cars, one on top of the other and side by side.

The system is a drive-through system combined with TrendVario 6100, 6100+, 6200+, 6300 and 6300+ (for details about these systems please refer to the relevant product data sheets).

Dimensions are in accordance with the underlying dimensions of parking pit, height and width.

The parking bays are accessed horizontally (installation deviation $\pm 1\%$).

Along the complete width of the parking automat an approach lane (driving lane in accordance with local regulations) must be available. Parking spaces are arranged on three different levels, one level on top of the other.

The platforms of both the lower floor (LF) and upper floor (UF) are moved vertically, the platforms of the ground floor (GF) horizontally. At approach level (GF) there is always one parking space less available. This vacant space is used for shifting the ground floor (GF) parking spaces sideways, thus enabling an upper floor (UF) parking space or lower floor (LF) parking space to be lowered or lifted to approach level. Consequently, a unit of five parking spaces (2 on the upper floor, 1 on the ground floor, 2 on the lower floor) is the smallest unit available for this parking system.

For safety reasons the platforms can only be moved behind locked gates.

All necessary safety devices are installed. This consists mainly of a chain monitoring system, locking lever for the upper platforms and locked gates. The gates can only be opened if the selected parking space has reached the park position.

A steel framework mounted to the floor consisting of:

- Columns (arranged in rows)
- Cross and longitudinal members
- running rails for the transversely movable ground floor (GF) platforms

Platforms consisting of:

- Platform profiles
- Adjustable wheel stops
- Canted access plate
- Side members
- Traverses
- Bridge (only LF)
- Screws, nuts, washer, distance tubes, etc.

Lifting device for upper floor (UF) and lower floor (LF) platforms:

- Hydraulic cylinder with solenoid valve
- Chain wheels
- Chains
- Limit switches
- The platforms are suspended on four points and guided along the supports using plastic sliding bearings

Drive unit of transversely movable platforms on the ground floor (GF):

- Gear motor with chain wheel
- Chains
- Running and guide rollers (low-noise)
- Power supply via cable chain

Hydraulic unit consisting of:

- Hydraulic power unit (low-noise, installed onto a console with a rubber-bonded-to-metal mounting)
- Hydraulic oil reservoir
- Oil filling
- Internal geared wheel pump
- Pump holder
- Clutch
- AC-motor (3,0 kW, 230/400 V, 50 Hz)
- Motor circuit breaker
- Test manometer
- Pressure relief valve
- Hydraulic hoses (which reduce noise transmission onto the hydraulic pipe)

Control system:

- Central control panel (operating device) used to select the desired parking space
- Electric wiring is made from the electric cabinet by the manufacturer

Vertical gate:

Size

Dimensions modified based on width and height measurements. Gate consists of two segments.

Frame

- Frame construction with two vertical centre stay bars made from extruded aluminium profiles (anodized, layer thickness approx. 20 μm)
- For a neat connection to the building, a rubber lip is attached to the closing edge.

Standard gate panel

- Perforated aluminium plate
- Thickness 2 mm, RV 11/8 E6/EV1, anodized, layer thickness approx. 20 μm
- Ventilation cross-section of the panelling approx. 40%

Please note:

Gate panels (on the side, cover for running rails, etc.) and gate suspensions are not included in the standard version but can be delivered against surcharge as special equipment.

Page 1
Section
Vehicle data

Page 2
Height
dimensions

Page 3
Vertical gate
width
dimensions

Page 4
Sliding gate
width
dimensions

Page 5
Sliding gate
width
dimensions

Page 6
Sliding gate
width
dimensions

Page 7
Arrangement of
the grid
Approach
Free spaces
Function

Page 8
Load plan

Page 9
Technical
data

Page 10
Electrical
To be performed by
the customer

Page 11
Description

Page 12
Description

Description

Sliding gates

Size

Sliding gate, dimensions: approx. 2500 mm x 2000 mm (width x height).

Frame

- Frame construction with vertical centre stay bar made from extruded aluminium profiles (anodized, layer thickness approx. 20 µm).
- To open the doors a recessed grip is integrated in the aluminium profile.
- A rubber lip is used for the finishing of the closing edge to the building.

Standard gate panel

Perforated steel plate

- Thickness 1 mm, RV 5/8, galvanized, layer thickness: approx. 20 µm
- Ventilation cross-section of the panel approx. 40%
- Not suitable for outdoor garages

Alternative gate panel

Perforated aluminium plate

- Thickness 2 mm, RV 5/8 E6/EV1, anodized, layer thickness: approx. 20 µm.
- Ventilation cross-section of the panel approx. 40%

Beaded steel plate

- Thickness 1mm, galvanized, layer thickness: approx. 20 µm .
- additional power coating, layer thickness: approx. 25 µm on the outside and approx. 12 µm [0.0005"] on the inside.
- Colour options for the outside (building view):
RAL 1015 (light ivory), RAL 3003 (ruby),
RAL 5014 (pigeon blue), RAL 6005 (moss green),
RAL 7016 (anthracite grey), RAL 7035 (light grey),
RAL 7040 (window grey), RAL 8014 (sepia),
RAL 9006 (white aluminium), RAL 9016 (traffic white)
- Inside of the gates in light grey

Plain aluminium sheet

- Thickness 2 mm, E6/EV1, anodized, layer thickness: approx. 20 µm.

Wooden panelling

- Nordic spruce in grade A
- vertical tongue and groove boards
- preimpregnated colourless

Verbundsicherheitsglas

- VSG aus ESG 8/4 mm

Wire grating

- Mesh size 12 x 12 mm

Running rails

- The running gear of each gates consists of 2 twin-pair rolling gadgets, adjustable in height
- The running rails of the gates are fixed to brackets or the concrete lintel, or on a building-specific gate suspension using ceiling fittings
- The guide consists of 2 plastic rollers mounted to a base plate, which is dowelled to the floor
- Running rails, ceiling fittings and guide roller base plate are hot-dip galvanized

Gate actuation

Standard:

- Manually, i.e. the gate is opened and closed by hand

Alternatively:

- Electric drive via electric motor mounted to the rail system at the turning point of the sliding gates. The drive pinion engages into the chain mounted to the gate.

For safety reasons the movement of the platforms is always made behind locked gates. Position sensing, i.e. "gate open" and "gate closed" is effected by electric signalers.

Separation (if necessary):

- Upon request

Please note:

Gatepanels (on the side, cover for running rails, etc.) and gate suspensions are not included in the standard version but can be delivered against surcharge as special equipment.

We reserve the right to change this specification without further notice

KLAUS Multiparking reserves the right in the course of technical progress to use newer or other technologies, systems, processes, procedures or standards in the fulfillment of their obligations other than those originally offered provided the customer derives no disadvantage from their so doing