

Page 1
Section
Dimensions
Car data
Page 2
Width dimensions
Page 3
Approach
Load plan
Page 4
Pit
Paving
Page 5
Electrical installation
Technical data
Page 6
Tec. data
To be performed by the customer
Page 7
Description



KLAUS Multiparking GmbH
 Hermann-Krum-Straße 2
 D-88319 Aitrach
 Fon +49 (0) 75 65 508-0
 Fax +49 (0) 75 65 508-88
 info@multiparking.com
 www.multiparking.com

PRODUCT DATA



multibase U20 EB

2000 kg¹ / 2600 kg²

Dimensions

All space requirements are minimum finished dimensions.

Tolerances for space requirements +3³.
 Dimensions in cm.

EB (single platform) = 2 vehicles

Suitable for

Standard passenger cars:
 Limousine, station wagon, SUV, van
 according to clearance and maximal
 surface load.

	Standard	Special ²
width	190 cm ⁴	190 cm ⁴
weight	max. 2000 kg	max. 2600 kg
wheel load	max. 500 kg	max. 650 kg

Clearance profile

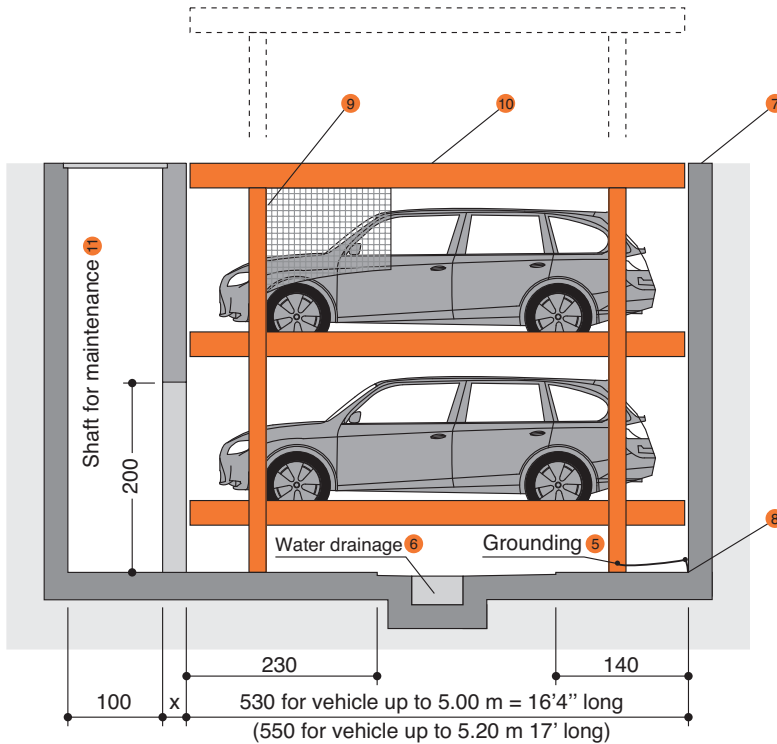
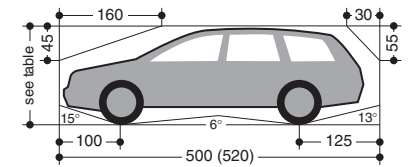

U20 EB

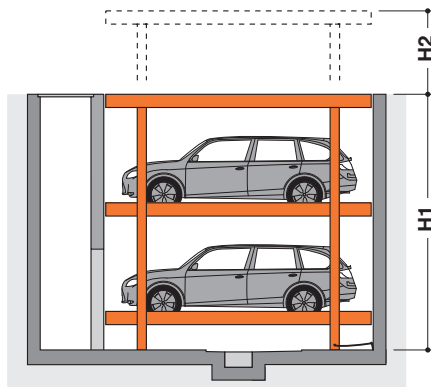

Type	H1	H2	car height
U20 EB-425	425	375	165
U20 EB-435	435	385	170
U20 EB-445	445	395	175
U20 EB-455	455	405	180
U20 EB-465	465	415	185
U20 EB-475	475	425	190
U20 EB-485	485	435	195
U20 EB-495	495	445	200

- 1 Standard type
- 2 Special system: maximum load for extra charge.
- 3 To follow the minimum finished dimensions, make sure to consider the tolerances according to VOB, part C (DIN 18330 and 18331) and the DIN 18202.
- 4 Car width for platform width 230 cm. If wider platforms are used it is also possible to park wider cars.
- 5 Potential equalization from foundation grounding connection to system (provided by the customer).
- 6 Slope with drainage channel and sump see page 3.
- 7 In compliance with DIN EN 14010, 10 cm wide yellow-black markings compliant to ISO 3864 must be applied by the customer to the edge of the pit in the entry area to mark the danger zone (see „load plan“ page 4).
- 8 At the transition section between pit floor and walls no hollow mouldings/coves are possible. If hollow mouldings/coves are required, the systems must be designed smaller or the pits accordingly wider.
- 9 If necessary, protective gratings are installed at the back area
- 10 The upper platform is a frame construction. Flooring can be provided by the customer (e.g. soil/turf, sandbed/turfblock, sandbed/marble, etc.). Maximum weight of customer coating 250 kg/m².
 The upper platform is at ground level and is traversible when in lowered position (vehicle load: 2600 kg maximum, wheel load: 650 kg maximum). On special conditions the upper platform may be used as parking space.
- 11 A separate maintenance manhole must be installed by the customer (with manhole cover, ladder and a connecting passage to the pit). A save maintenance access with a door has to be provided by the customer – please contact KLAUS Multiparking. The hydraulic power unit and ventilation system are also housed in the maintenance manhole

! After operation, the system must always be run into the lowest final position (key interlock).

Page 1
Section
Dimensions
Car data

Page 2
Width
dimensions

Page 3
Approach
Load plan

Page 4
Pit
Paving

Page 5
Electrical
installation
Technical
data

Page 6
Tec. data
To be performed by the customer

Page 7
Description

Width dimensions

Top view closed pit

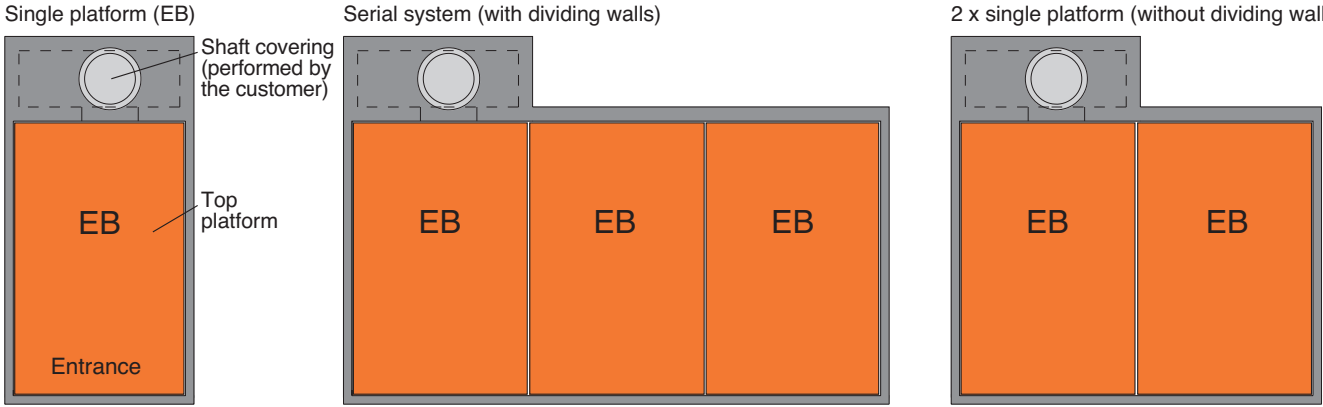

Pit dimensions

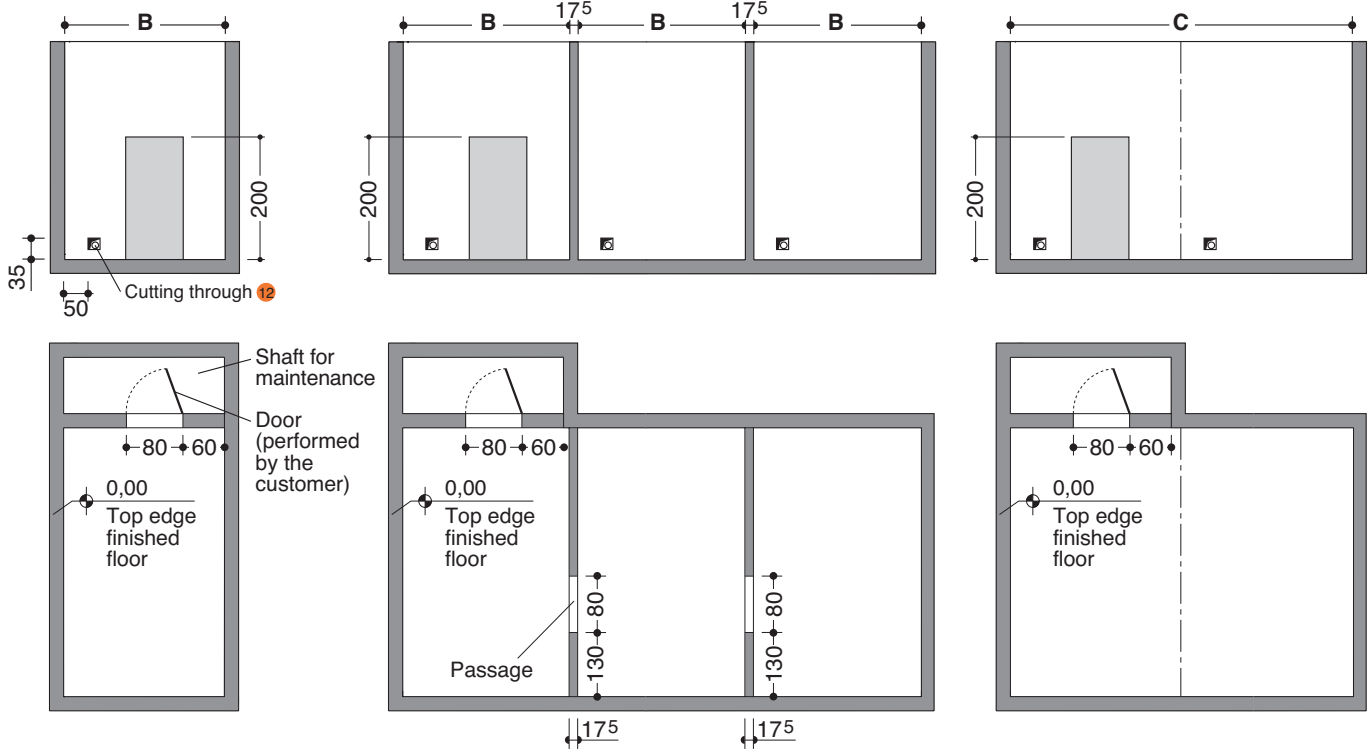

Pit dimension B	Usable platform width parking levels	Usable platform width top platform	Pit dimension C	Usable platform width parking levels	Usable platform width top platform
275	230	270	550	2 x 230	2 x 270
285	240	280	570	2 x 240	2 x 280
295	250	290	590	2 x 250	2 x 290
305	260	300	610	2 x 260	2 x 300
315	270	310	630	2 x 270	2 x 310

! All sidewalls must be in a rectangular angel. Max. tolerances are 1 cm!
Warning: If the side or backside is freely accessible these areas must be safeguarded (railing, marking etc.). Measures to be taken according to project.
 End parking spaces are generally more difficult to drive into. Therefore we recommended for end parking spaces our wider platforms. Parking on standard width platforms with larger vehicles may make getting into and out of the vehicle difficult. This depends on type of vehicle, approach and above all on the individual driver's skill.
 For vehicle widths larger 190 cm a platform width of 270/540 cm is required in order to enable the driver to get in and out of the car on one side.

12 For dividing walls: cutting through 15 x 15 cm.

Page 1
Section
Dimensions
Car data

Page 2
Width
dimensions

Page 3
Approach
Load plan

Page 4
Pit
Paving

Page 5
Electrical
installation
Technical
data

Page 6
Tec. data
To be performed
by the
customer

Page 7
Description

Approach

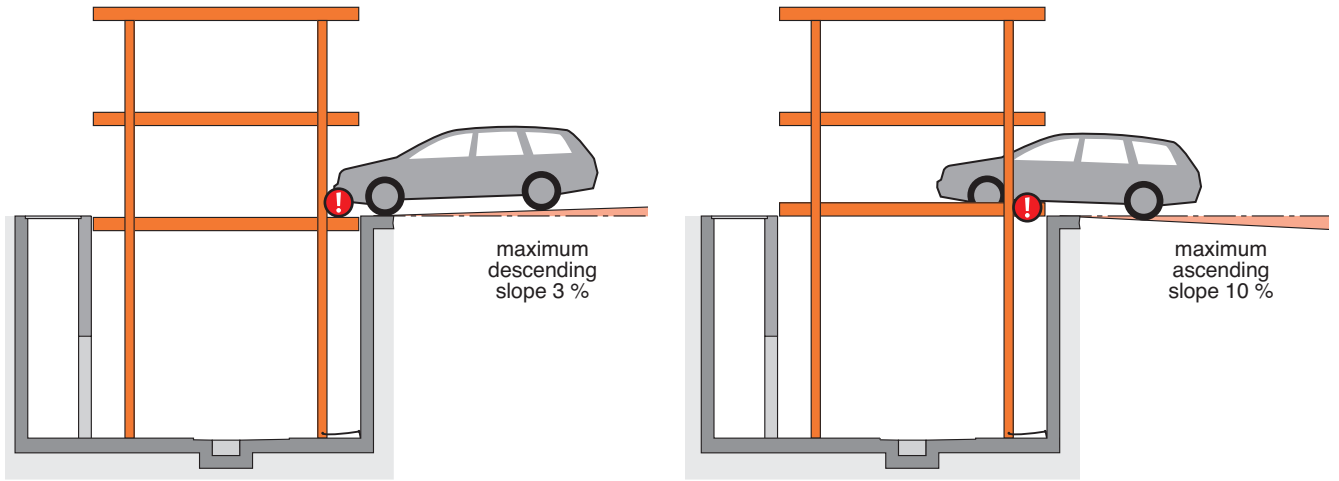

! The illustrated maximum approach angles must not be exceeded. Incorrect approach angles will cause serious manoeuvring & positioning problems on the parking system for which the local agency of KLAUS Multiparking accepts no responsibility.

Load plan

Section

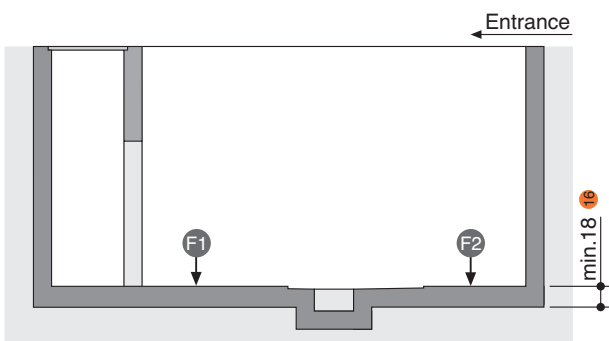

U20 EB

Upper platform with sheet metal plates

Upper platform with stone layer

usable platform width	F1	F2	¹⁵	usable platform width	F1	F2
EB 2000 kg	+68	+34		EB 2000 kg	+74	+37
EB 2600 kg	+74	+37		EB 2600 kg	+80	+40

Top view

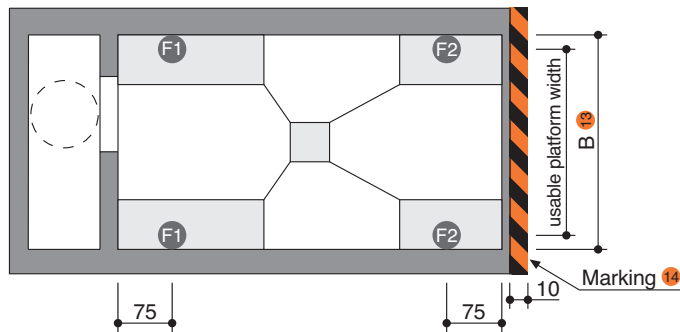

! Units are dowelled to the floor. Drilling depth: approx. 15 cm.
Floor and walls below the drive-in level are to be made of concrete (quality minimum C20/25)!

¹³ Dimension B see page 2

¹⁴ Marking compliant to ISO 3864 (colors used in this illustration are not ISO 3864 compliant)

¹⁵ All forces in kN

¹⁶ The loading capacity of the base plate must be proved by a structural engineer. Possibly stronger base plate could be necessary.

- Page 1
Section
Dimensions
Car data
- Page 2
Width
dimensions
- Page 3
Approach
Load plan
- Page 4
Pit
Paving
- Page 5
Electrical
installation
Technical
data
- Page 6
Tec. data
To be performed
by the
customer
- Page 7
Description

Pit edge/Drainage

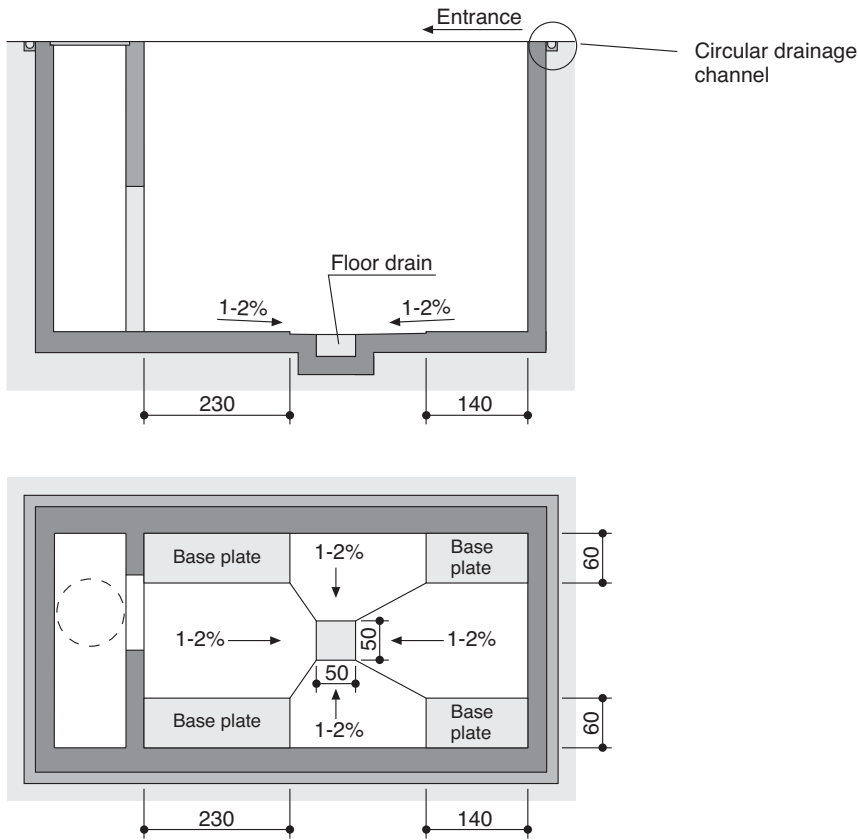

On-site coating of the uppermost platform

Maximum weight of customer coating 250 kg/m².

Coating with asphalt or concrete

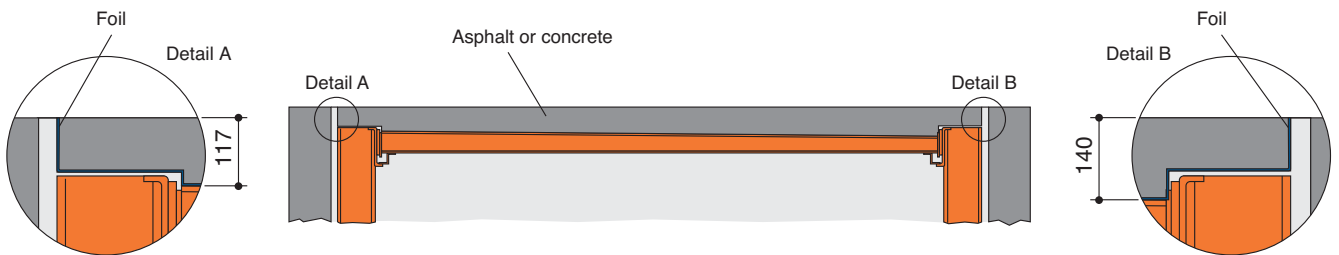

Before filling, the trough must be lined with a water-impermeable foil by a specialist company on site.

Dimensions rounded.

Coating with paving stones or turf grids

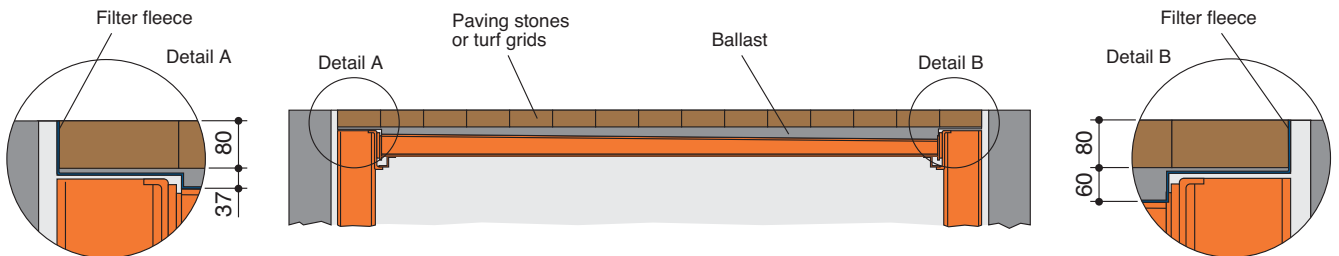

Before paving, the trough must be lined with a water-permeable filter fleece by a specialist company on site.

Dimensions rounded.

Page 1
Section
Dimensions
Car data

Page 2
Width
dimensions

Page 3
Approach
Load plan

Page 4
Pit
Paving

Page 5
Electrical
installation
Technical
data

Page 6
Tec. data
To be performed by
the customer

Page 7
Description

Electrical installation

Installation diagram

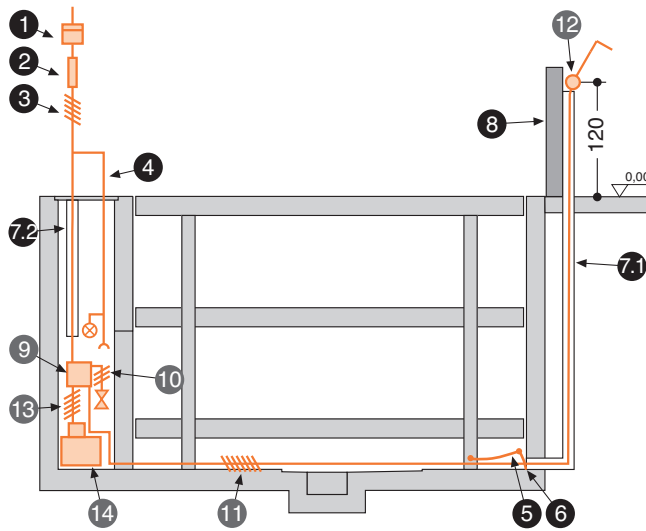

Electrical data (to be performed by the customer)

No.	Quantity	Description	Position	Frequency
1	1	Electricity meter	in the supply line	
2	1	Main fuse: U20 EB: 3 x fuse 25 A (slow) or circuit breaker 3 x 25 A (trigger characteristic K or C)	in the supply line	1 per unit
3	1	Supply line (3 PH + N + PE) with marked wire and protective conductor: U20 EB: 5 x 6 mm ²	to main switch	1 per unit
4	1	Separate supply line (230 V) with lighting and power outlet	from supply line into the shaft	1 per system
5	every 10 m	Foundation earth connector	corner pit floor	
6	1	Equipotential bonding in accordance with DIN EN 60204 from foundation earth connector to the system		1 per system
7.1	1	Empty pipe DN 40 with taut wire	base pit to operating device	1 per system
7.2	1	Empty pipe DN 40 with taut wire	supply line to hydraulic unit	1 per system
8	1	Stand for operating device		1 per system

Electrical data (included in delivery of KLAUS Multiparking)

No.	Description
9	Control box with lockable main switch
10	Control line 3 x 0.75 mm ² (PH + N + PE)
11	Control line 7 x 1 mm ² with marked wire and protective conductor
12	Operating device
13	Control line 5 x 2.5 mm ² with marked wire and protective conductor
14	Hydraulic unit with three-phase current, 230/400 V, 50 Hz: U20 EB: 7.5 kW

Technical data

Field of application

By default, the system can only be used for a fixed number of users. If required, would you please contact us.

Units

Low-noise power units mounted to rubber-bonded-to metal mountings are installed. Nevertheless we recommend that parking system's garage be built separately from the dwelling.

Available documents

- maintenance offer/contract
- declaration of conformity

Building application documents

According to LBO and GaVo (garage regulations) the Multiparking systems are subject to approval. We will provide the required building application documents.

Corrosion protection

See separate sheet regarding corrosion protection.

Care

To avoid damages resulting from corrosion, make sure to follow our cleaning and care instructions and to provide good ventilation of your garage.

Railings

If the permissible drop opening is exceeded, railings are to be mounted on the systems. If there are traffic routes next to or behind the installations, railings compliant to DIN EN ISO 13857 must be installed by the customer. Railings must also be in place during construction.

Environmental conditions

Environmental conditions for the area of multiparking systems: Temperature range -10 to +40° C. Relative humidity 50% at a maximum outside temperature of +40° C.

If lifting or lowering times are specified, they refer to an environmental temperature of +10° C and with the system set up directly next to the hydraulic unit. At lower temperatures or with longer hydraulic lines, these times increase.

CE Certification

The systems offered correspond to DIN EN 14010 and the EC Machinery Directive 2006/42/EG.

Page 1
Section
Dimensions
Car data

Page 2
Width
dimensions

Page 3
Approach
Load plan

Page 4
Pit
Paving

Page 5
Electrical
installation
Technical
data

Page 6
Tec. data
To be performed by the
customer

Page 7
Description

Technical data

Sound insulation

According to DIN 4109 (Sound insulation in buildings), para. 4, annotation 4, KLAUS Multiparkers are part of the building services (garage systems).

Normal sound insulation:

DIN 4109, para. 4, Sound insulation against noises from building services.

Table 4 in para. 4.1 contains the permissible sound level values emitted from building services for personal living and working areas. According to line 2 the maximum sound level in personal living and working areas must not exceed 30 dB (A).
Noises created by users are not subject to the requirements (see table 4, DIN 4109).

The following measures are to be taken to comply with this value:

- Sound protection package according to offer/order (KLAUS Multiparking GmbH)
- Minimum sound insulation of building $R'_W = 57$ dB (to be provided by customer)

Increased sound insulation (special agreement):

Draft DIN 4109-10, Information on planning and execution, proposals for increased sound insulation.

Agreement: Maximum sound level in personal living and working areas 25 dB (A). *Noises created by users are not subject to the requirements (see table 4, DIN 4109).*

The following measures are to be taken to comply with this value:

- Sound protection package according to offer/order (KLAUS Multiparking GmbH)
- Minimum sound insulation of building $R'_W = 62$ dB (to be provided by customer)

Note: User noises are noises created by individual users in our Multiparking systems. These can be noises from accessing the platforms, slamming of vehicle doors, motor and brake noises.

To be performed by the customer

Safety fences

Any constraints that may be necessary according to DIN EN ISO 13857 in order to provide protection for the park pits for pathways directly in front, next to or behind the unit. This is also valid during construction. Railings for the system are included in the series delivery when necessary.

Numbering of parking spaces

Consecutive numbering of parking spaces.

Building services

Any required lighting, ventilation, fire extinguishing and fire alarm systems as well as clarification and compliance with the relevant regulatory requirements.

Drainage

In the middle of the pit a floor drain with connection to the cable network or a pump sump is to be provided. The water is to be drained with a pump to be provided by the customer. From the pit corners/bearing surface of the lifting columns an incline to the floor drain/pump sump is necessary.

For reasons of environmental protection we recommend to paint the pit floor, and to provide oil and petrol separators in the connections to the public sewage network.

To divert large amounts of water from the court area, we recommend that the customer install a water drainage channel around the periphery of the pit.

Marking

According to DIN EN 14 010, a warning that identifies this danger area must be placed in the entrance area that conforms to ISO 3864. This must be done according to EN 92/58/EWG for systems with a pit (platforms within the pit) 10 cm from the edge of the pit.

Wall cuttings

Any necessary wall cuttings according to page 2.

Operating device

The customer must provide a cable duct (Helfamin-tube) from pit floor to operating device. The location of the control element must be specified according to the project (control stand, house wall, etc.).

Installing vertical columns

In general, a crane must be supplied by the customer for installation of the telescope columns.

Hook clearance min. 700 cm over access level, crane load approx. 1400 kg.

Electrical supply to the main switch / Foundation earth connector

Suitable electrical supply to the main switch must be provided by the customer during installation. The functionality can be monitored on site by our fitters together with the electrician. If this cannot be done during installation for some reason for which the customer is responsible, the customer must commission an electrician at their own expense and risk.

In accordance with DIN EN 60204 (Safety of Machinery. Electrical Equipment), grounding of the steel structure is necessary, provided by the customer (distance between grounding max. 10 m).

Maintenance manhole

A separate maintenance manhole with manhole cover, ladder and a connecting passage to the pit must be installed by the customer. In multiple systems, a shared maintenance manhole may be sufficient, depending on the project.

Lighting

The customer must comply with DIN 67528 »Artificial lighting of parking areas and parking houses« for the parking structure lighting. The intensity of illumination in the pit and in the maintenance manhole must be min. 80 Lux.

Ventilation

To achieve a constant exchange of air, reduce humidity, prevent condensation, and reduce vehicle moisture (due to rain, snow, ice, etc.), it is recommended that the customer consult specialized engineers for heating, ventilation, and climate control and install a ventilation system. This will reduce or prevent the hazard of corrosion and its attendant failures.

If the following are not included in the quotation, they will also have to be provided / paid for by the customer:

- Mounting of contactor and terminal box to the wall valve, complete wiring of all elements in accordance with the circuit diagram
- Costs for final technical approval by an authorized body
- Main switch
- Control line from main switch to hydraulic unit

Coating on the uppermost platform

Coating with asphalt or concrete:

- Before filling, the trough must be lined with a water-impermeable foil by a specialist company on site.

Coating with paving stones or turf grids:

- Before paving, the trough must be lined with a water-permeable filter fleece by a specialist company on site.

Page 1
Section
Dimensions
Car data

Page 2
Width
dimensions

Page 3
Approach
Load plan

Page 4
Pit
Paving

Page 5
Electrical
installation
Technical
data

Page 6
Tec. data
To be performed by the
customer

Page 7
Description

Description Single platform (EB)

General description:

Multiparking system providing independent parking spaces for 2 cars (EB) one on top of the other each.

Dimensions are in accordance with the underlying dimensions of parking pit, height and width.

The parking bays are accessed horizontally (installation deviation $\pm 1\%$).

Vehicles are positioned on each parking space using wheel stops on the right side (adjust according to operating instructions).

Operation via operating device with key interlock using master keys.

Operating instructions are attached to each operator's stand.

Multiparking system consisting of:

- 2 telescopic lifting columns at rear with hydraulic cylinder (mounted to the floor)
- 2 telescopic lifting columns at front (mounted to the floor)
- 1 upper platform (for floor coating to be provided by the customer, e.g. sand layer/stone layer, please KLAUS Multiparking). Maximum weight of customer coating 250 kg/m²
Optional design with platform sheet metal plates from KLAUS Multiparking, against surcharge.
- 2 lower platforms
- 1 mechanic synchronization control system (to ensure synchronous operation of the hydraulic cylinders while lowering and lifting the platform)
- 2 hydraulic cylinders
- Dowels, screws, connecting elements, bolts, etc.
- The platforms and parking spaces are end-to-end accessible for parking!

Upper platform consisting of:

- Covering plates
- Side members
- Cross members
- Tray for customer coating, optional platform sheet metal plates from KLAUS Multiparking
- Screws, nuts

Lower platforms consisting of:

- Platform base sections
- Adjustable wheel stops
- Cantled access plates
- Side members
- Cross members
- Screws, nuts, washers, distance tubes, etc.

Hydraulic system consisting of:

- Hydraulic cylinder
- Magnetic valve
- Hydraulic conduits
- Screwed joints
- High-pressure hoses
- Installation material

Electric system consisting of:

- Operating device (Emergency Stop, lock, 1 master key per parking space)
- Terminal box at wall valve

Hydraulic unit consisting of:

- Hydraulic power unit (low-noise, installed onto a console with a rubber-bonded-to-metal mounting)
- Hydraulic oil reservoir
- Oil filling
- Internal geared wheel pump
- Pump holder
- Clutch
- 3-phase-AC-motor
- Contactor (with thermal overcurrent relay and control fuse)
- Test manometer
- Pressure relief valve
- Hydraulic hoses (which reduce noise transmission onto the hydraulic pipe)

We reserve the right to change this specification without further notice

KLAUS Multiparking reserves the right in the course of technical progress to use newer or other technologies, systems, processes, procedures or standards in the fulfillment of their obligations other than those originally offered provided the customer derives no disadvantage from their so doing.